

Inbouwcontactdoos

Bestelnr. 1270



- schroefklemmen
- 20° hoek

Technische informatie

Ampère	16 A
Polen	2 p
Voltage	20-25 V
Hertz	50-60 Hz
Aansluittechniek	schroefklemmen
Contacten	standaard
Beschermingsgraad	IP 44
Flens	68x62 mm
Bevestigingsgaten	53x47 mm
Hoek	20 °
Gewicht	125 g
Certificeringen	EAC

Tekeningen

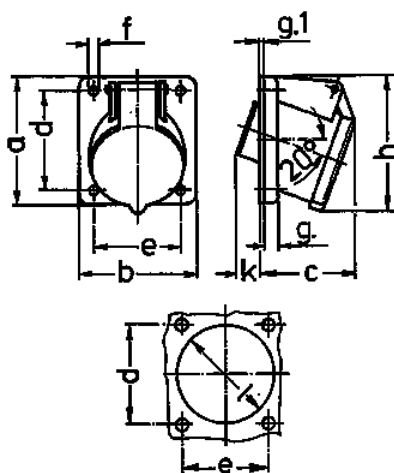

Tekening	Amp.	16		32	
		2	3	2	3
1 MB 231	Polen				
Maten in mm	a	68	68	68	68
	b	62	62	62	62
	c	42	42	42	42
	d	53	53	53	53
	e	47	47	47	47
	f	4,5	4,5	4,5	4,5
	g.	8	8	8	8
	g.1	2	2	2	2
	h	72	72	72	72
	k	32	32	32	32
	l	55	55	55	55
Kabelaansluiting					
van/tot mm²		4	4	4	4
		—10	—10	—10	—10