

## Toestelcontactstop

Bestelnr. 1975



- schroefklemmen
- met buitenliggende bevestigingen
- kabelinvoer 1 x bov en 1 x blind (breekpoort) aan de achterzijde

## Technische informatie

Ampère	32 A
Polen	3 p
Voltage	20-25 V
Hertz	50-60 Hz
Aansluittechniek	schroefklemmen
Contacten	standaard
Beschermingsgraad	IP 44
Gewicht	166 g
Certificeringen	EAC

## Tekeningen

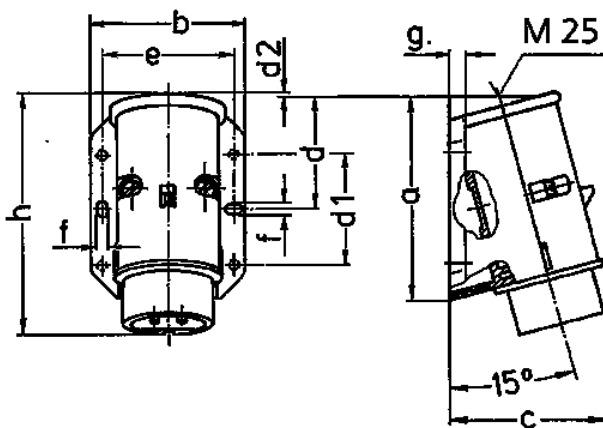

Tekening	Amp.	16		32	
		2	3	2	3
<b>2 MB 160</b>	<b>Polen</b>				
<b>Maten in mm</b>	<b>a</b>	96	96	96	96
	<b>b</b>	73	73	73	73
	<b>c</b>	74	74	74	74
	<b>d</b>	53	53	53	53
	<b>d1</b>	52	52	52	52
	<b>d2</b>	2	2	2	2
	<b>e</b>	62	62	62	62
	<b>f</b>	5,3	5,3	5,3	5,3
	<b>g.</b>	8	8	8	8
	<b>h</b>	116	116	116	116
<b>Kabelaansluiting</b>					
<b>van/tot mm<sup>2</sup></b>		4	4	4	4
		—10	—10	—10	—10