

Contactstop AM-TOP®

Bestelnr. 20709



- schroefklemmen
- ééndelige behuizing
- hittebestendig binnenwerk
- vernikkelde contacten
- wartel met afdichting
- trekontlasting met knikbescherming

Technische informatie

Ampère	32 A
Polen	4 p
Voltage	400 V
Uurstand	6 h
Hertz	50-60 Hz
Aansluittechniek	schroefklemmen
Contacten	vernikkelde contacten, hittebestendig binnenwerk
Beschermingsgraad	IP 67
Gewicht	316 g
Certificeringen	VDE, EAC

Tekeningen

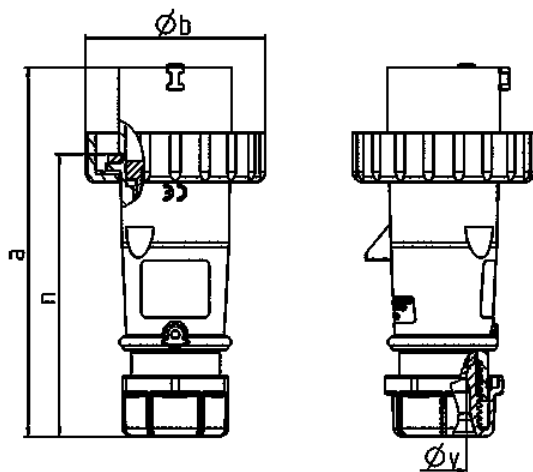

Tekening	Amp. Polen	16			32		
		3	4	5	3	4	5
Maten in mm	a	142	144	147	186	186	180
	b	70	78	87	94	94	101
	n	109	111	114	145	145	138
	y	14,5	16	16	22	22	22
Kabelaansluiting		1	1	1	2,5	2,5	2,5
van/tot mm²		-2,5	-2,5	-2,5	-6	-6	-6