

## Toestelcontactdoos

Bestelnr. 337



- schroefklemmen
- in de behuizing is een uitbreekpoort aanwezig

## Technische informatie

Ampère	16 A
Polen	4 p
Voltage	500 V
Uurstand	7 h
Hertz	50-60 Hz
Aansluittechniek	schroefklemmen
Contacten	standaard
Beschermingsgraad	IP 44
Gewicht	237 g
Certificeringen	VDE, EAC, CQC

## Tekeningen

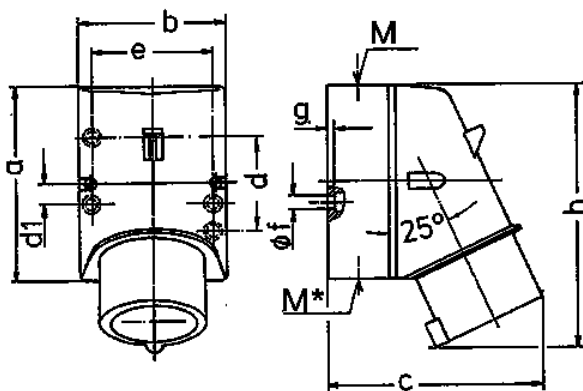

Tekening	Amp.	16			32		
		3	4	5	3	4	5
<b>2 MB 32</b>	<b>Polen</b>						
<b>Maten in mm</b>	<b>a</b>	87	100	100	128	128	128
	<b>b</b>	64	75	75	84	84	84
	<b>c</b>	93	106	110	133	133	135
	<b>d</b>	40	—	—	—	—	—
	<b>d1</b>	—	10,5	10,5	11	11	11
	<b>e</b>	50,5	59	59	68	68	68
	<b>f</b>	4,5	5	5	5,3	5,3	5,3
	<b>g</b>	4	4	4	4	4	4
	<b>h</b>	122	133	135	169	169	170
	<b>M</b>	20	20	20	32	32	32
	<b>M*</b>	1x20 (blind) breekpoort			2x25 (blind) breekpoort		
<b>Kabel Ø tot mm</b>		15	15	15	18/25	18/25	18/25
<b>Kabelaansluiting van/tot mm²</b>		1	1	1	2,5	2,5	2,5
		-2,5	-2,5	-2,5	-6	-6	-6