

Toestelcontactdoos

Bestelnr. 340



- schroefklemmen
- in de behuizing is een uitbreekpoort aanwezig

Technische informatie

Ampère	16 A
Polen	5 p
Voltage	110 V
Uurstand	4 h
Hertz	50-60 Hz
Aansluittechniek	schroefklemmen
Contacten	standaard
Beschermingsgraad	IP 44
Gewicht	246 g
Certificeringen	VDE, EAC, CQC

Tekeningen

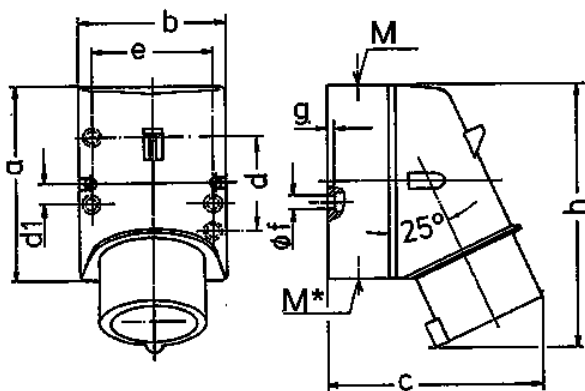

Tekening	Amp.	16			32		
		3	4	5	3	4	5
2 MB 32	Polen						
Maten in mm	a	87	100	100	128	128	128
	b	64	75	75	84	84	84
	c	93	106	110	133	133	135
	d	40	—	—	—	—	—
	d1	—	10,5	10,5	11	11	11
	e	50,5	59	59	68	68	68
	f	4,5	5	5	5,3	5,3	5,3
	g	4	4	4	4	4	4
	h	122	133	135	169	169	170
	M	20	20	20	32	32	32
	M*	1x20 (blind) breekpoort			2x25 (blind) breekpoort		
Kabel Ø tot mm		15	15	15	18/25	18/25	18/25
Kabelaansluiting van/tot mm²		1	1	1	2,5	2,5	2,5
		-2,5	-2,5	-2,5	-6	-6	-6