

Toestelcontactdoos

Bestelnr. 348



- schroefklemmen
- kabelinvoer is ook aan de achterzijde mogelijk
- in de behuizing is een uitbreekpoort aanwezig

Technische informatie

Ampère	32 A
Polen	4 p
Voltage	400 V
Uurstand	6 h
Hertz	50-60 Hz
Aansluittechniek	schroefklemmen
Contacten	standaard
Beschermingsgraad	IP 44
Gewicht	353 g
Certificeringen	VDE, EAC, CQC

Tekeningen

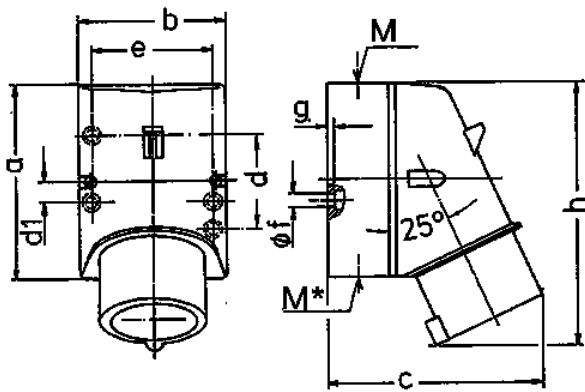

Tekening	Amp. Polen	16			32		
		3	4	5	3	4	5
2 MB 32							
Maten in mm							
a		87	100	100	128	128	128
b		64	75	75	84	84	84
c		93	106	110	133	133	135
d		40	—	—	—	—	—
d1		—	10,5	10,5	11	11	11
e		50,5	59	59	68	68	68
f		4,5	5	5	5,3	5,3	5,3
g		4	4	4	4	4	4
h		122	133	135	169	169	170
M		20	20	20	32	32	32
M*		1x20 (blind) breekpoort			2x25 (blind) breekpoort		
Kabel Ø tot mm		15	15	15	18/25	18/25	18/25
Kabelaansluiting van/tot mm²		1	1	1	2,5	2,5	2,5
		-2,5	-2,5	-2,5	-6	-6	-6