

Cepex-inbouwcontactdoos, alpine wit

Bestelnr. 4273



- schroefklemmen
- met tekstvenster
- tevens geschikt voor wandgoot en energiezuilen

Technische informatie

Ampère	16 A
Polen	4 p
Voltage	400 V
Uurstand	6 h
Hertz	50-60 Hz
Beschermingsgraad	IP 44
Aanrakingsveiligheid	false
Gewicht	181 g
Certificeringen	VDE, EAC

Tekeningen

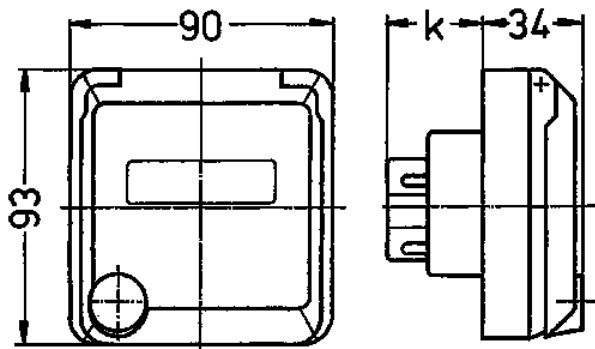

Tekening	Amp.	16			32		
		3	4	5	3	4	5
1 MB 318	Polen						
Maten in mm	k	32	32	32	48	48	48
Kabelaansluiting		1,5	1,5	1,5	2,5	2,5	2,5
van/tot mm²		—4	—4	—4	—6	—6	—6