

Toestelcontactstop

Bestelnr. 432



- schroefklemmen

Technische informatie

Ampère	16 A
Polen	5 p
Voltage	400 V
Uurstand	6 h
Hertz	50-60 Hz
Aansluittechniek	schroefklemmen
Contacten	standaard
Beschermingsgraad	IP 44
Gewicht	227 g
Certificeringen	VDE, EAC

Tekeningen

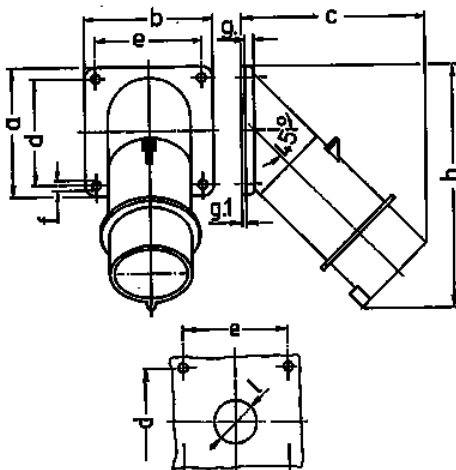

Tekening	Amp. Polen	16		32	
		5	3	4	5
Maten in mm	a	85	85	85	85
	b	85	85	85	85
	c	122	126	126	129
	d	70	70	70	70
	e	70	70	70	70
	f	6,2	6,2	6,2	6,2
	g	6	6	6	6
	g.1	2	2	2	2
	h	161	163	163	170
	i	30	30	30	30
Kabelaansluiting		1	2,5	2,5	2,5
van/tot mm²		—2,5	—6	—6	—6