

Toestelcontactstop

Bestelnr. 800



- schroefklemmen
- met buitenliggende bevestiging

Technische informatie

Ampère	16 A
Polen	4 p
Voltage	400 V
Uurstand	6 h
Hertz	50-60 Hz
Aansluittechniek	schroefklemmen
Contacten	standaard
Beschermingsgraad	IP 44
Gewicht	201 g
Certificeringen	VDE, EAC

Tekeningen

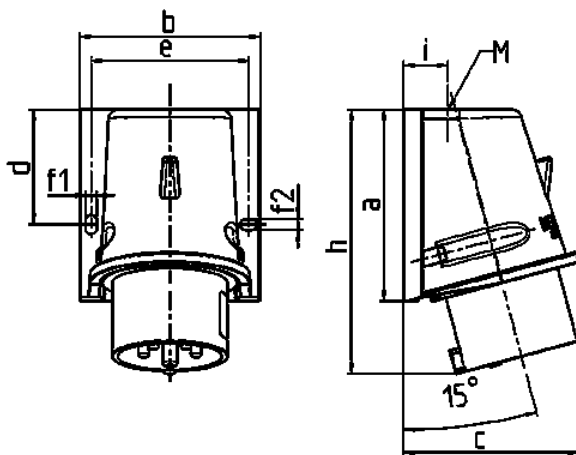

Tekening	Amp.	16		32		
		4	5	3	4	5
2 MB 221	Polen					
Maten in mm	a	92,5	92,5	102	102	102
	b	87	87	94	94	94
	c	84,5	84,5	94	94	94
	d	55,5	55,5	62	62	62
	e	76	76	84	84	84
	f1	5,3	5,3	5,3	5,3	5,3
	f2	5,3	5,3	5,3	5,3	5,3
	h	128	128	146	146	146
	i	21,5	21,5	26	26	26
	M	25x1,5	25x1,5	25x1,5	25x1,5	32x1,5