

## Toestelcontactstop

Bestelnr. 801



- schroefklemmen
- met buitenliggende bevestiging

## Technische informatie

Ampère	16 A
Polen	5 p
Voltage	400 V
Uurstand	6 h
Hertz	50-60 Hz
Aansluittechniek	schroefklemmen
Contacten	standaard
Beschermingsgraad	IP 44
Gewicht	215 g
Certificeringen	VDE, EAC

## Tekeningen

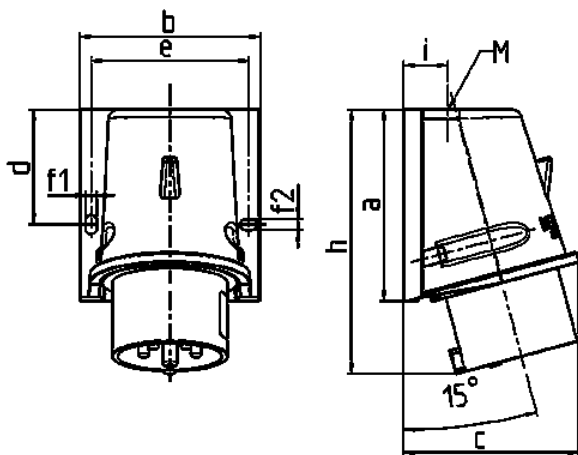

Tekening	Amp.	16		32		
		4	5	3	4	5
<b>2 MB 221</b>	<b>Polen</b>					
<b>Maten in mm</b>	<b>a</b>	92,5	92,5	102	102	102
	<b>b</b>	87	87	94	94	94
	<b>c</b>	84,5	84,5	94	94	94
	<b>d</b>	55,5	55,5	62	62	62
	<b>e</b>	76	76	84	84	84
	<b>f1</b>	5,3	5,3	5,3	5,3	5,3
	<b>f2</b>	5,3	5,3	5,3	5,3	5,3
	<b>h</b>	128	128	146	146	146
	<b>i</b>	21,5	21,5	26	26	26
	<b>M</b>	25x1,5	25x1,5	25x1,5	25x1,5	32x1,5