

Toestelcontactstop

Bestelnr. 835

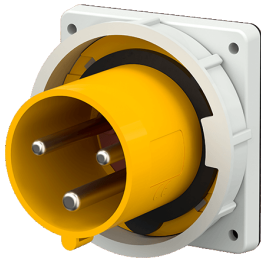

- schroefklemmen
- hittebestendig binnenwerk
- vernikkelde contacten
- bij toepassing is een nok voor het klapdeksel van de koppelcontactstop noodzakelijk

Technische informatie

Ampère	63 A
Polen	3 p
Voltage	110 V
Uurstand	4 h
Hertz	50-60 Hz
Aansluittechniek	schroefklemmen
Contacten	hittebestendig binnenwerk, vernikkelde contacten
Beschermingsgraad	IP 67
Gewicht	478 g
Certificeringen	VDE, EAC, CQC

Tekeningen

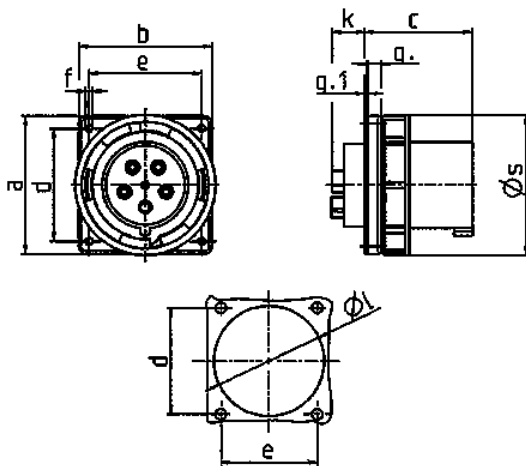

Tekening	Amp. Polen	63			125		
		3	4	5	3	4	5
2 MB 166							
Maten in mm							
a		110	110	110	130	130	130
b		106	106	106	130	130	130
c		86	86	86	112	112	112
d		90	90	90	104	104	104
e		90	90	90	104	104	104
f		5,5	5,5	5,5	6,5	6,5	6,5
g		12	12	12	18	18	18
g.1		2	2	2	2	2	2
k		28	28	28	28	28	28
l		88,5	88,5	88,5	95	95	95
s		113	113	113	132	132	132
Kabelaansluiting van/tot mm²							
		6	6	6	25	25	25
		-16	-16	-16	-70	-70	-70