

## Koppelcontactstop PowerTOP®

Bestelnr. 3888



- schroefklemmen
- hittebestendig binnenwerk
- wartel en buitenliggende trekcontasting

### Technische informatie

Ampère	32 A
Polen	3 p
Voltage	230 V
Uurstand	6 h
Hertz	50-60 Hz
Aansluittechniek	schroefklemmen
Contacten	hittebestendig binnenwerk
Beschermingsgraad	IP 67
Gewicht	363 g
Certificeringen	VDE, EAC, CQC

### Tekeningen

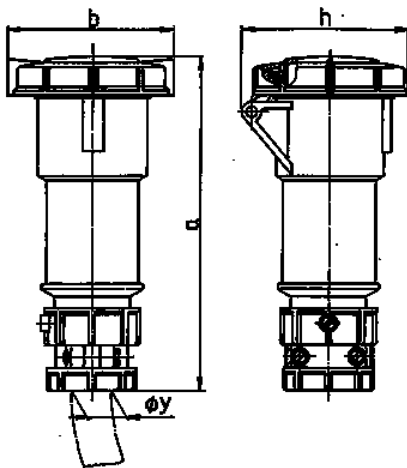

Tekening	Amp. Polen	16			32		
		3	4	5	3	4	5
<b>Maten in mm</b>	<b>a</b>	171	182	194	217	217	229
	<b>b</b>	78	85	96	103	103	110
	<b>h</b>	79	88	95	99	99	105
	<b>y</b>	19	19	22	24,5	24,5	28,5
<b>Kabelaansluiting</b>		1	1	1	2,5	2,5	2,5
<b>van/tot mm²</b>		-2,5	-2,5	-2,5	-6	-6	-6