

## Koppelcontactstop PowerTOP®

Bestelnr. 3974



- schroefklemmen
- hittebestendig binnenwerk
- wartel en buitenliggende trekcontasting

### Technische informatie

Ampère	32 A
Polen	5 p
Voltage	110 V
Uurstand	4 h
Hertz	50-60 Hz
Aansluittechniek	schroefklemmen
Contacten	hittebestendig binnenwerk
Beschermingsgraad	IP 44
Gewicht	420 g
Certificeringen	EAC

### Tekeningen

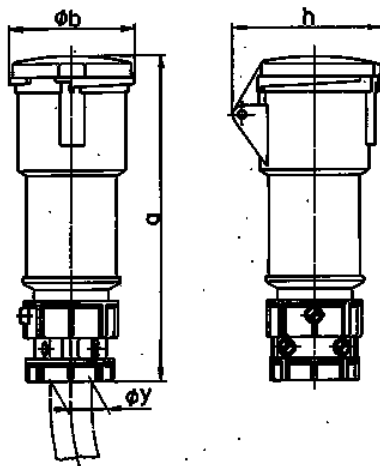

Tekening	Amp. Polen	16			32		
		3	4	5	3	4	5
<b>Maten in mm</b>	<b>a</b>	165	180	190	214	214	223
	<b>b</b>	60	68	76	82	82	89
	<b>h</b>	76	84	90	92	92	99
	<b>y</b>	19	19	22	24,5	24,5	28,5
<b>Kabelaansluiting</b>		1	1	1	2,5	2,5	2,5
<b>van/tot mm²</b>		-2,5	-2,5	-2,5	-6	-6	-6