

Koppelcontactstop PowerTOP®

Bestelnr. 3976



- schroefklemmen
- hittebestendig binnenwerk
- wartel en buitenliggende trekcontasting

Technische informatie

Ampère	32 A
Polen	5 p
Voltage	400 V
Uurstand	6 h
Hertz	50-60 Hz
Aansluittechniek	schroefklemmen
Contacten	hittebestendig binnenwerk
Beschermingsgraad	IP 44
Gewicht	422 g
Certificeringen	EAC, CQC

Tekeningen

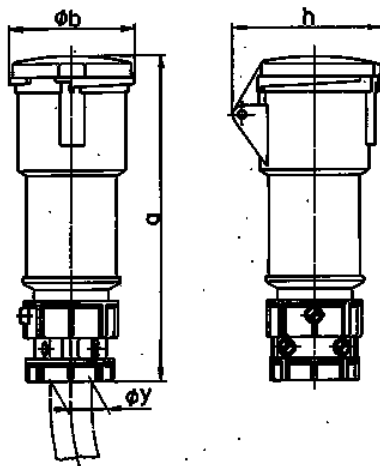

Tekening	Amp. Polen	16			32		
		3	4	5	3	4	5
Maten in mm	a	165	180	190	214	214	223
	b	60	68	76	82	82	89
	h	76	84	90	92	92	99
	y	19	19	22	24,5	24,5	28,5
Kabelaansluiting		1	1	1	2,5	2,5	2,5
van/tot mm²		-2,5	-2,5	-2,5	-6	-6	-6