

Contactstop AM-TOP®

Bestelnr. 741



- schroefklemmen
- hittebestendig binnenwerk
- vernikkelde contacten
- ééndelige behuizing
- wartel met afdichting
- trekontlasting en knikbescherming

Technische informatie

Ampère	16 A
Polen	7 p
Voltage	230 V
Uurstand	9 h
Hertz	50-60 Hz
Aansluittechniek	schroefklemmen
Contacten	vernikkelde contacten, hittebestendig binnenwerk
Beschermingsgraad	IP 44
Gewicht	195 g
Certificeringen	EAC, CQC

Tekeningen

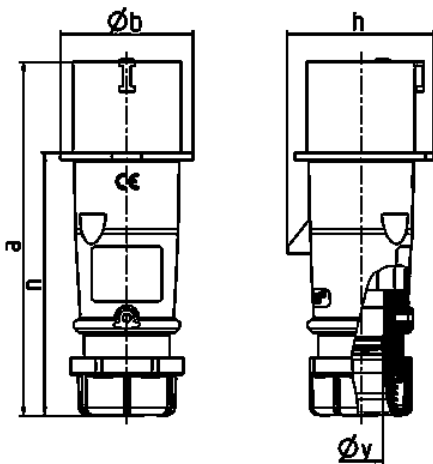

Tekening	Amp. Polen	16		32	
		7		7	
Maten in mm	a	147		180	
	b	67		77	
	h	76		89,5	
	n	110		135	
	y	16		22	
Kabelaansluiting		1		2,5	
van/tot mm²		—2,5		—6	