

Stekker AM-TOP®

Bestelnr. 22326

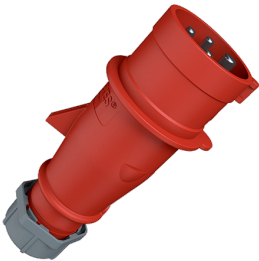

- schroefklemmen
- ééndelige behuizing
- hittebestendig binnenwerk
- vernikkelde contacten
- wartel met afdichting
- trekontlasting en knikbescherming

Technische gegevens

Ampère	32 A
Polen	4 p
Voltage	400 V
Uurstand	6 h
Hertz	50-60 Hz
Aansluittechniek	schroefklemmen
Contacten	vernikkelde contacten, hittebestendig binnenwerk
Beschermingsgraad	IP44
Gewicht	230 g
Certificeringen	VDE, EAC, CQC

Afmetingen

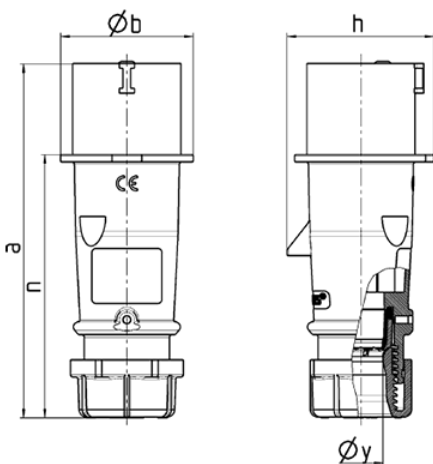

Tekening	Amp.	16			32		
		3	4	5	3	4	5
2 MB 217	Polen						
Maten in mm	a	142	147	147	186	186	180
	b	53	59	67	70	70	77
	h	59	69,4	76	81	81	89,5
	n	105	110	110	141	141	135
	y	14,5	16	16	22	22	22
Kabelaansluiting		1	1	1	2,5	2,5	2,5
	van/tot mm²	-2,5	-2,5	-2,5	-6	-6	-6