

Wandcontactdoos

Bestelnr. 2983A



- schroefklemmen
- binnenbevestiging
- kabelinvoer 1 x boven en 2 x onder (blind)
- behuizing 180° draaibaar bij 5-polige uitvoering

Technische gegevens

Ampère	32 A
Polen	4 p
Voltage	50-500 V
Uurstand	1 h
Aansluittechniek	schroefklemmen
Contacten	standaard
Beschermingsgraad	IP44
Gewicht	360 g
Certificeringen	VDE, EAC, CQC

Afmetingen

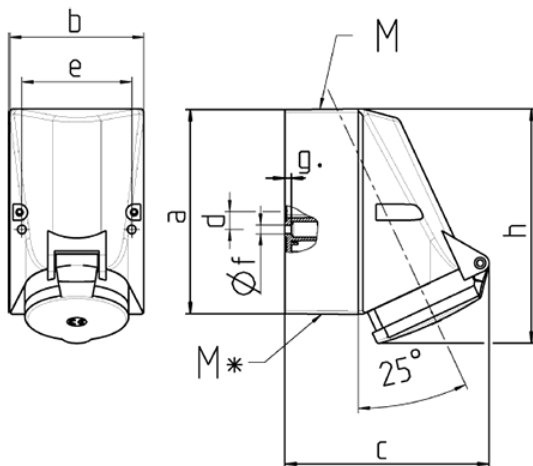

Tekening 1 MB 43	Amp. Polen	16		32			
		4	5	3	4	5	
Maten in mm		a	128	128	128	128	128
	b	84	84	84	84	84	
	c	122	124	136	136	138	
	d	11	11	11	11	11	
	e	68	68	68	68	68	
	f	5,3	5,3	5,3	5,3	5,3	
	g.	4	4	4	4	4	
	h	144	145	158	158	160	
	M	25	25	32	32	32	
	M*	2x25 (blind) breekpoort		2x25 (blind) breekpoort			
	Kabel Ø tot mm	18	18	18/25	18/25	18/25	
	Kabelaansluiting van/tot mm ²	1,5	1,5	2,5	2,5	2,5	
		-4	-4	-10	-10	-10	