

## Cepex inbouwcontactdoos, wit

Bestelnr. 4115



- schroefklemmen
- tevens geschikt voor wandgoot en energiezuilen
- slagvast volgens DIN 18032

### Technische gegevens

Ampère	16 A
Polen	5 p
Voltage	400 V
Uurstand	6 h
Hertz	50-60 Hz
Beschermingsgraad	IP44
Aanrakingsveiligheid	false
Gewicht	187 g
Certificeringen	VDE, EAC, CQC

### Afmetingen

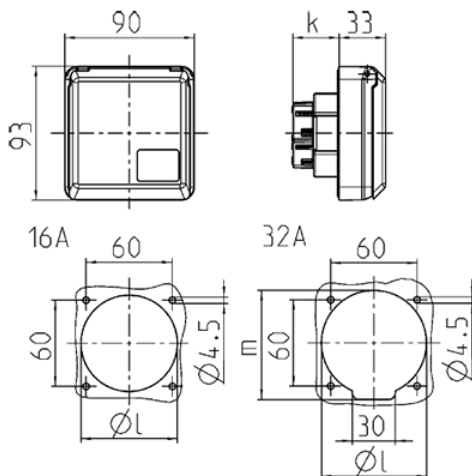

Tekening	Amp.	16			32		
		3	4	5	3	4	5
1 MB 315	Polen						
Maten in mm	k	32	32	32	48	48	48
	l	55	60	67	65	65	73
	m	-	-	-	70	70	76
Kabelaansluiting van/tot mm <sup>2</sup>		1,5	1,5	1,5	2,5	2,5	2,5
		—4	—4	—4	—6	—6	—6