

Koppeling AM-TOP®

Bestelnr. 550



- schroefklemmen
- ééndelige behuizing
- wartel met afdichting
- trekontlasting en knikbescherming

Technische gegevens

Ampère	16 A
Polen	5 p
Voltage	400 V
Uurstand	6 h
Hertz	50-60 Hz
Aansluittechniek	schroefklemmen
Contacten	standaard
Beschermingsgraad	IP67
Gewicht	269 g
Certificeringen	VDE, EAC, CQC

Afmetingen

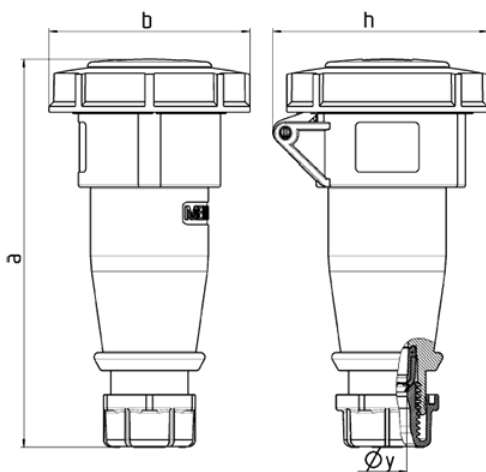

Tekening 3 MB 62	Amp. Polen	16			32		
		3	4	5	3	4	5
Maten in mm	a	146	166	172	212	212	213
	b	72	79	89	96	96	102
	h	80	88	95	98	98	105
	y	14,5	16	16	22	22	22
Kabelaansluiting		1	1	1	2,5	2,5	2,5
van/tot mm²		-2,5	-2,5	-2,5	-6	-6	-6