

Wandcontactdoos

Bestelnr. 7312



- schroefklemmen
- aardlekschakelaar (0,03 A)
- andere varianten op aanvraag

Technische gegevens

Ampère	16 A
Polen	5 p
Voltage	400 V
Uurstand	6 h
Hertz	50-60 Hz
Aansluittechniek	schroefklemmen
Contacten	standaard
Beschermingsgraad	IP44
Behuizing materiaal	Kunststof
Gewicht	1386 g
Certificeringen	EAC, CQC

Afmetingen

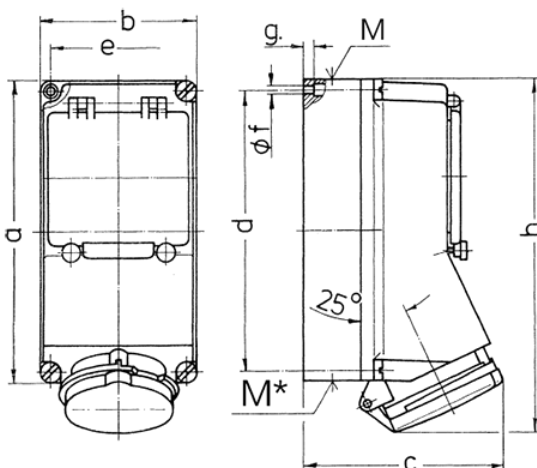

Tekening 1 MB 168	Amp. Polen	16			32			
		3	4	5	3	4	5	
Maten in mm		a	225	225	225	225	225	225
		b	118	118	118	118	118	118
		c	141	141	141	146	146	146
		d	208	208	208	208	208	208
		e	101	101	101	101	101	101
		f	6,3	6,3	6,3	6,3	6,3	6,3
		g	8	8	8	8	8	8
		h	250	252	254	264	264	264
		M	1x25 en 1x32			1x25 en 1x32		
		M*	2x25	2x25	2x25	2x25	2x25	2x25
Kabel Ø tot mm			25	25	25	25	25	25
Kabelaansluiting van/tot mm ²			1,5	1,5	1,5	2,5	2,5	2,5
			-4	-4	-4	-10	-10	-10