

Wall mounted receptacle DUOi R

Part Number.: 5812506TC



MENNEKES

Elektrotechnik GmbH & Co. KG
Aloys-Mennekes-Straße 1
57399 KIRCHHUNDEM GERMANY
www.MENNEKES.org

Product Description

- screw terminals
- LED voltage indicator
- pre-wired for installation
- X-CONTACT
- highly resistant to chemicals
- switched
- mechanical DUO-interlock
- highly heat resistant contact carrier
- nickel plated contacts
- switched N conductor, with auxiliary contact switch 2NC and 2NO
- receptacles can be padlocked
- sealed against dust, temporary submersion and high pressure cleaning
- enclosure base witho

Technical Details

Wall mounted receptacle - DUO	5812506TC
Product series	DUOi R
Switch Disconnecter	Yes
Ampere	16A
Number of Poles	5 P
Clock position	6 h
Voltage	400 V
Hertz	50-60 Hz
Current Type	AC
Switch Type	3P + N' + PE + 2NC + 2NO
Protection Type	IP67/IP69
Impact resistance	IK08
Contact carrier	Nickel-plated contacts Highly heat resistant X-CONTACT®

Pilot contact	Without pilot contact
Connection	Screw-terminals
LED voltage indicator	Yes Life expectancy: 10 years at ambient temperature +40 °C
Padlocked	Yes
Mounting method	Wall mounted
Cable entry	Top & bottom (without cable entry openings) 2 x M25 top or bottom closed 1 x M25 and 1 x M32 top or bottom closed
Weight (net)	1245 g
EAN / identification number	-

Permissible ambient conditions

Permanent ambient temperature min. - max.	-25 - +40 °C
---	--------------

Material properties

Hinged lid	PA6/TPE similar RAL 3013 red similar RAL 7016 anthracite
Upper enclosure part	PC/SI similar RAL 7000 grey
Enclosure base	PC/SI similar RAL 9005 deep black
Rotary Switch	PC/SI similar RAL 7000 grey
Material of exterior screws	PA6 similar RAL 9005 deep black

Material resistance

The material resistance overview can be found on the website in the "Knowledge" section → "Product knowledge" → "Materials"

Regulations and Standards

REACH (Regulation (EG) No. 1907/2006)	Information according to article 33 REACH: SVHC: Lead (CAS: 7439-92-1)
RoHS 2011/65/EU incl. 2015/863/EU	✓
POP Regulation (EU) 2019/1021	✓
Norm(s)	IEC 60309-4
Declaration of conformity	CE, UKCA
Test mark	-

Dimensional drawing

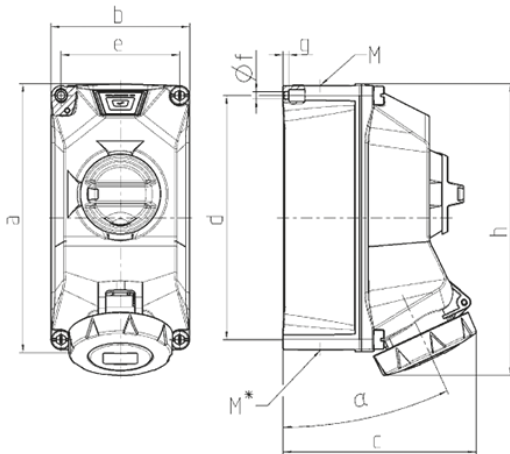

Drawing 1 MB 716	Amp. Poles	16			32		
		3	4	5	3	4	5
Dim. in mm	a	225	225	225	225	225	225
	b	118	118	118	118	118	118
	c	163	163	165	168	168	169
	d	208	208	208	208	208	208
	e	101	101	101	101	101	101
	f	6.4	6.4	6.4	6.4	6.4	6.4
	g	5	5	5	5	5	5
	h	241	245	249	252	252	255
	α	25			25		
	M	1x25 and 1x32			1x25 and 1x32		
	M*	2x25	2x25	2x25	2x25	2x25	2x25
	Max. cable diam. (mm)	25	25	25	25	25	25
	Terminal for cond. cross section (mm ²) min.-max.	2.5	2.5	2.5	2.5	2.5	2.5
		-10	-10	-10	-10	-10	-10